



DRC9

Autonomous dispenser / reloader
of magnetic cards for the payment
of copies and printings

www.rdtoffice.ro





THE DRC9 ADVANTAGES

According to the Cartadis DRC9STD chosen, magnetic reloadable Cartadis cards can be sold and reloaded against coin and/or banknote insertion and/or contactless bank card through the Nayax reader

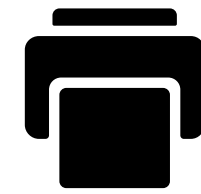

A full “self-service” operation of the copy and print service



An intuitive and ergonomic touchscreen that allows the display of the user credit and prices



Buying or reloading of cards with 6 decreasing prices available

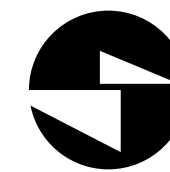

Buying and dispensing of reloadable Cartadis user cards.



For a site management without requiring staff for selling cards.

DRC9

It enables cards to be dispensed automatically to users who had none, or reloaded, whether their credit had already been spent out or not.

Such cards are solely intended for the Cartadis terminals of access control and payment for MFPs and printers.

With Cartadis DRC9STD and a set of Cartadis terminals, you can fit out a site of several copiers for full "self-service" operation.

This solution is particularly suitable in libraries, public sites, or educational environments.



Statistics

Reloading statistics can be read by the person in charge of the unit and viewed on the screen, or downloaded via an USB key.

These data consist of: receipt on the current period, receipt from installation and number of cards sold

12 / 30
last 30 days

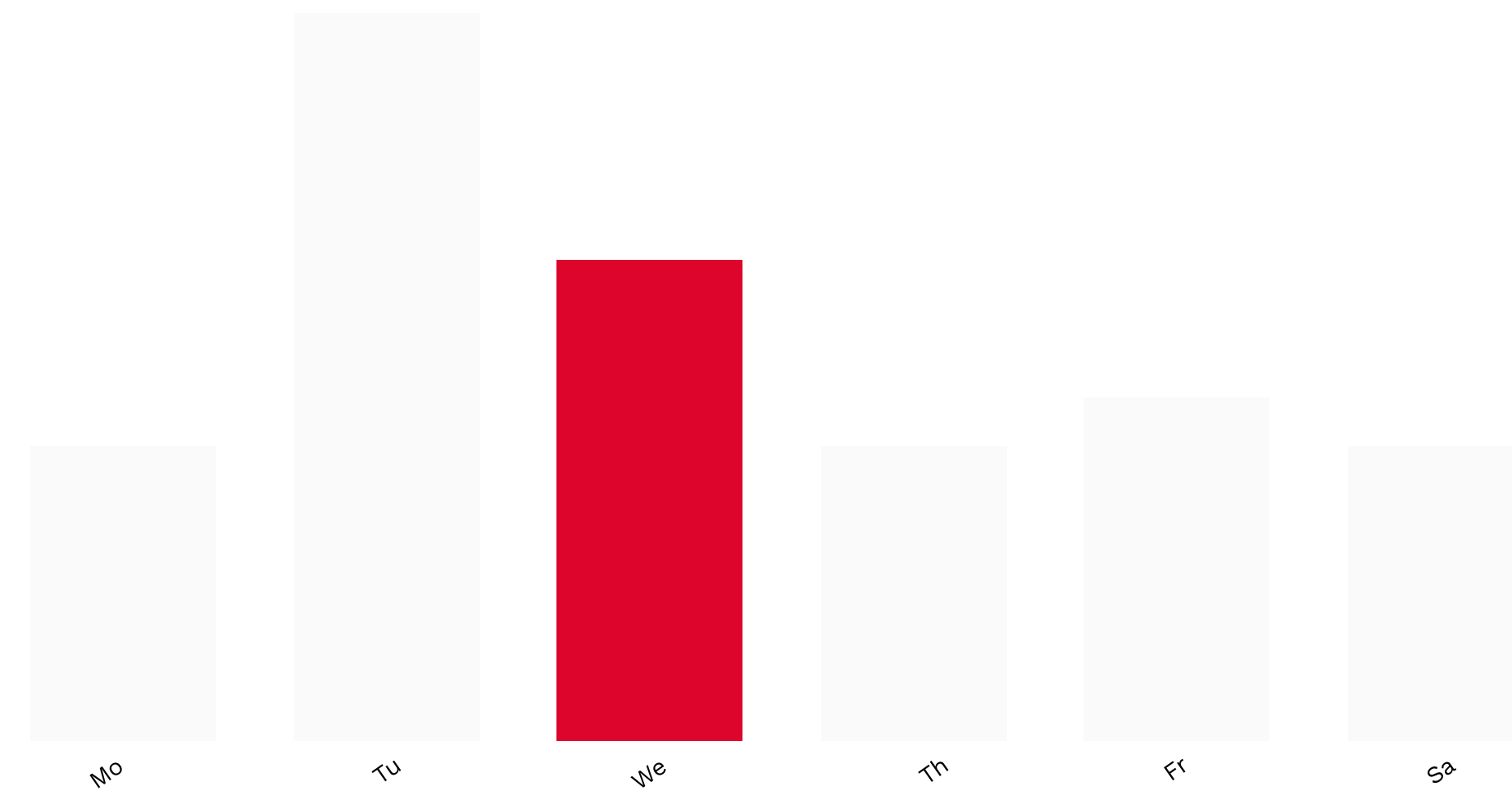

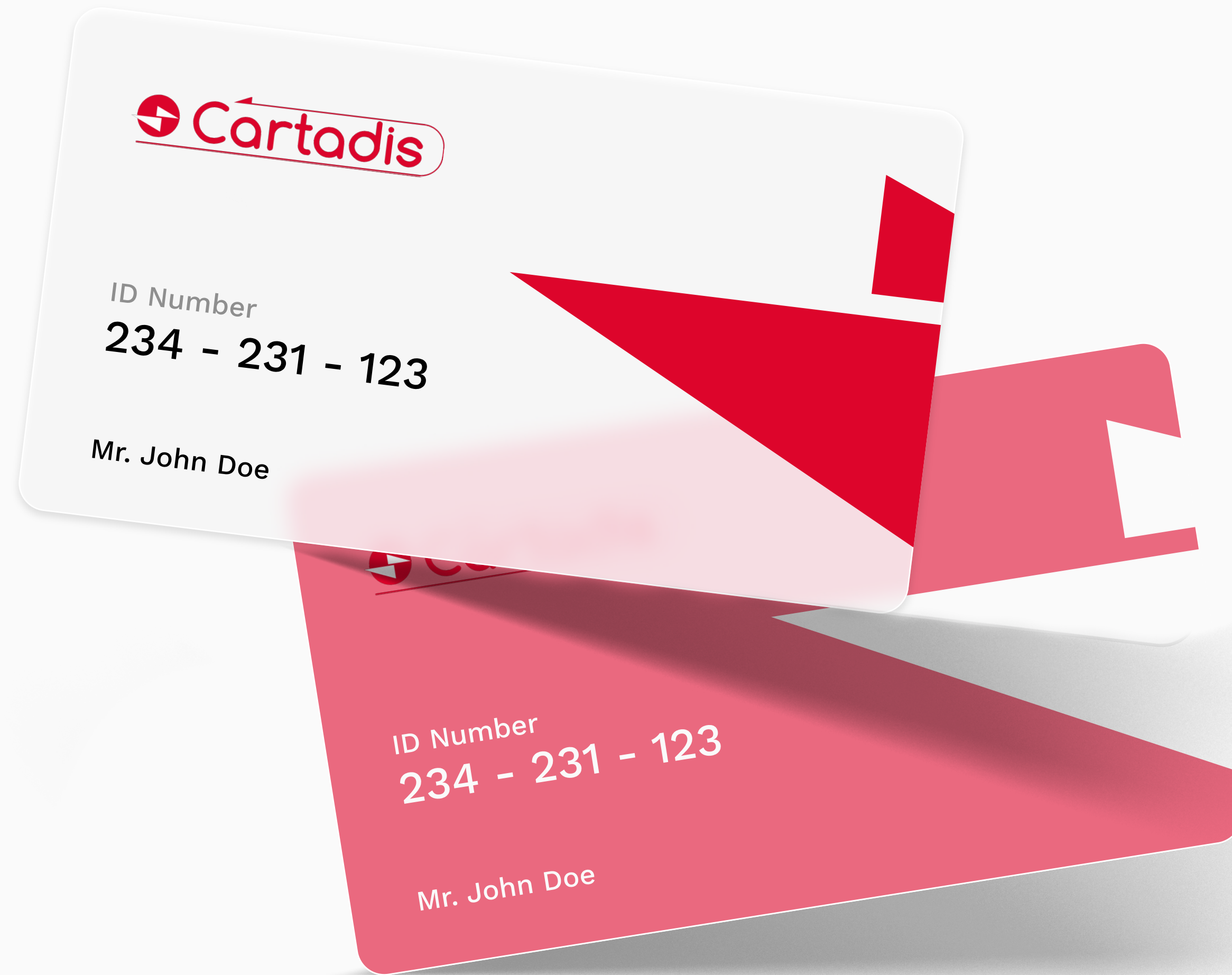

Exemple of use

Cartadis units are especially suitable for a use in a public or a university library.

This can be highlighted by the following example:

- ✓ The library is provided with 8 copiers equipped with Cartadis TC4N's.
- ✓ A Cartadis DRC9STD dispenser/reloader is installed at the entrance of the library.
- ✓ The user can buy or reload a card

CARD BUYING

Buying a card is composed of 4 steps:

01. Selecting of the service wished (buying or reloading) on the touchscreen,
02. Inserting money with simultaneous display of credit,
03. Recovering of the card dispensed in DRC9 receiver,
04. Inserting the card in the reader for credit loading.

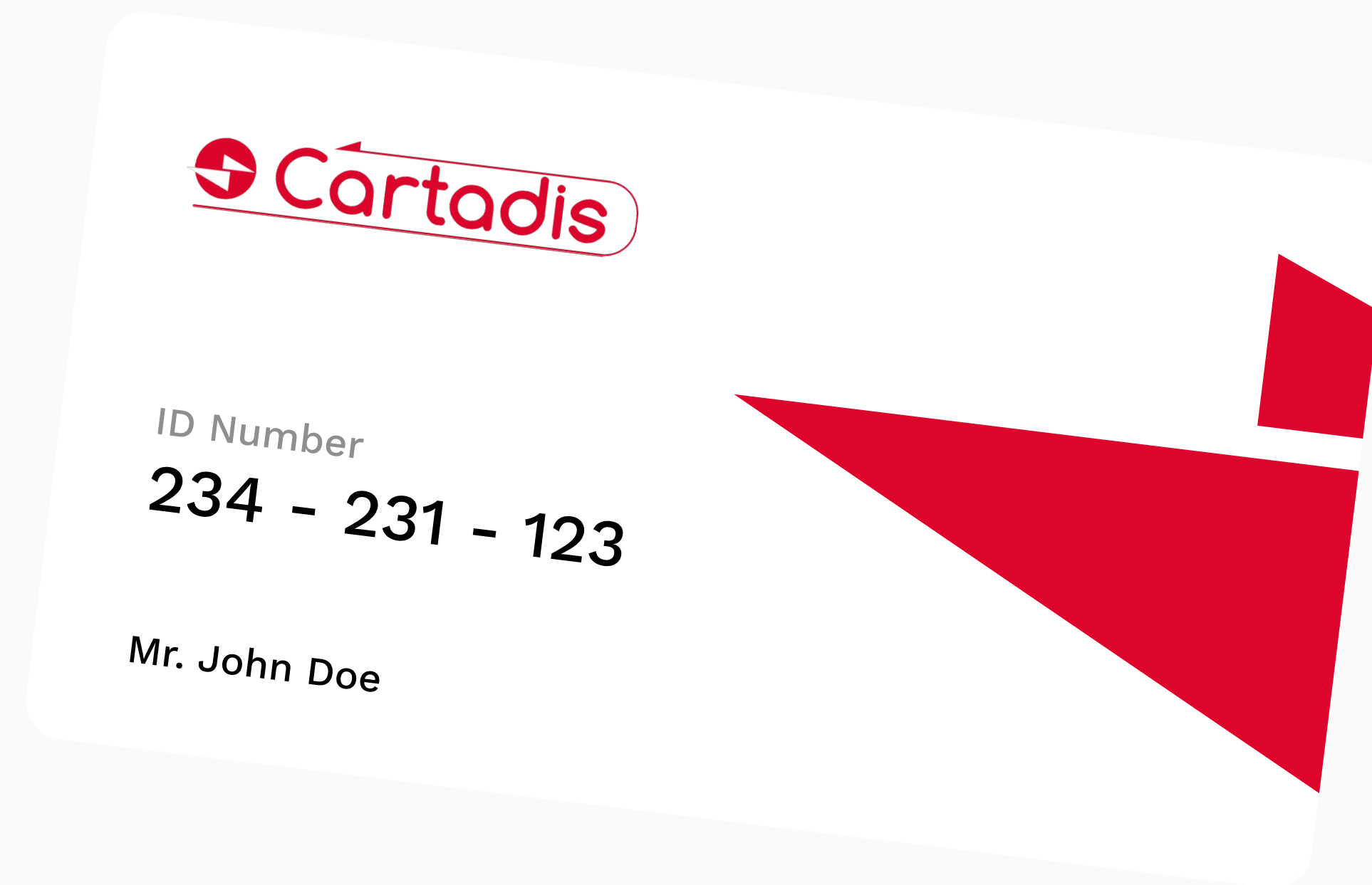

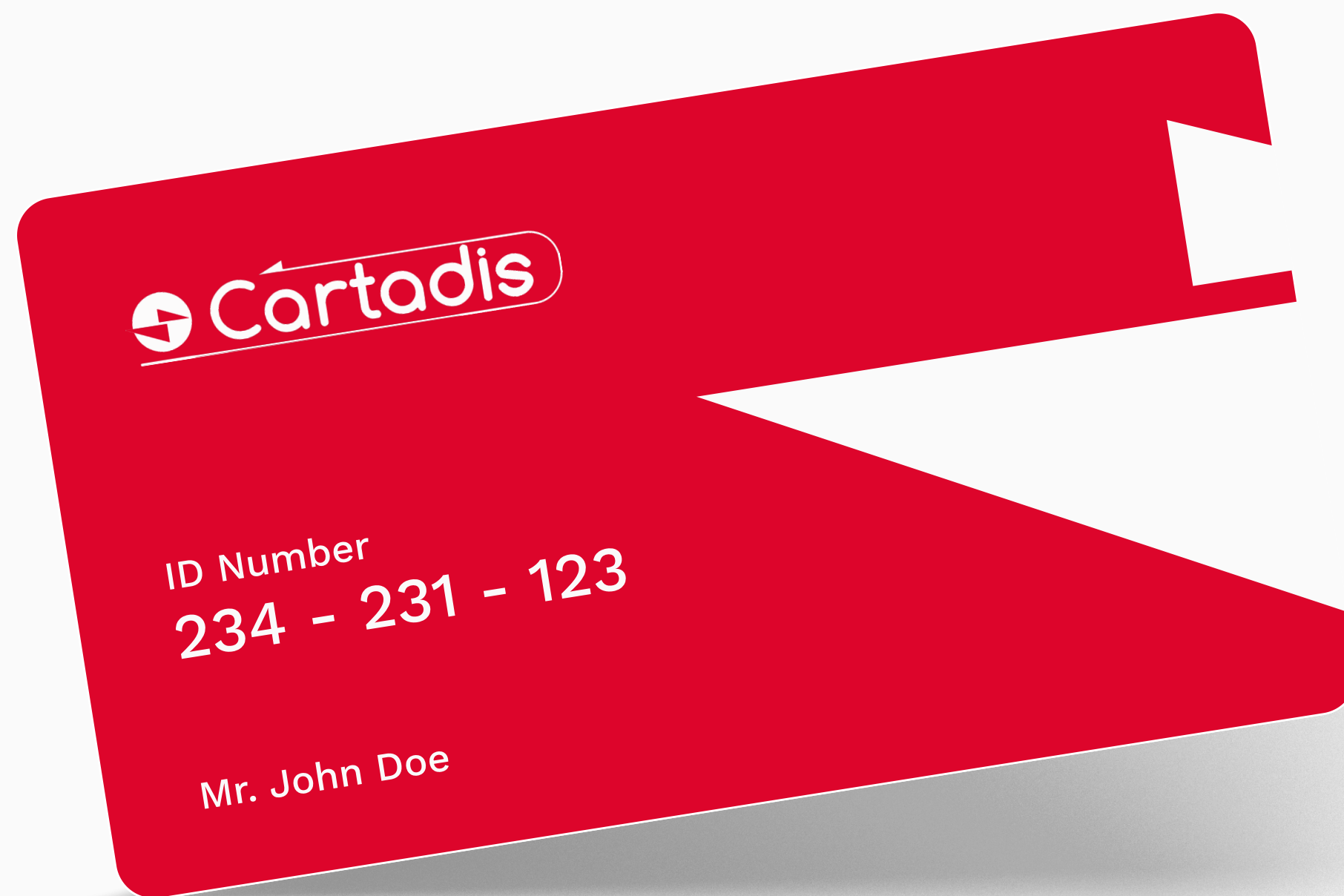

CARD RELOADING

Reloading a card is composed of 3 steps:

- 01 .Selecting of the service wished (buying or reloading) on the touchscreen,
02. Inserting money with simultaneous display of credit,
03. Inserting the card in the reader for credit loading

The range of DRC9 dispensers / reloaders

The range of DRC9 dispensers / reloaders enables the various ways of payment to be accepted.

	DRC9STD - P	DRC9STD P -B	DRC9STD - B
Coin mechanism (6 different coins)	✓	✓	✓
Banknote reader (3 different banknotes)		✓	✓
Contactless bank card			✓

Specifications

- Card feeder capacity: about 350 cards.
- Automatic withhold of the card dispensing when the feeder is empty, but reloading maintained.
- 7-inch touchscreen, resolution 800*480, 16 million colours.
- Housing in 2 mm thick plate, closed by a 3 point-lock.
- Choice of payment method: Coins, bills and credit card

Dimensions

↕ Height 910mm

↔ Width 480mm

↗ Depth 500mm

Optional

Receipt printer

Banknote stacker
(capacity 300 banknotes)

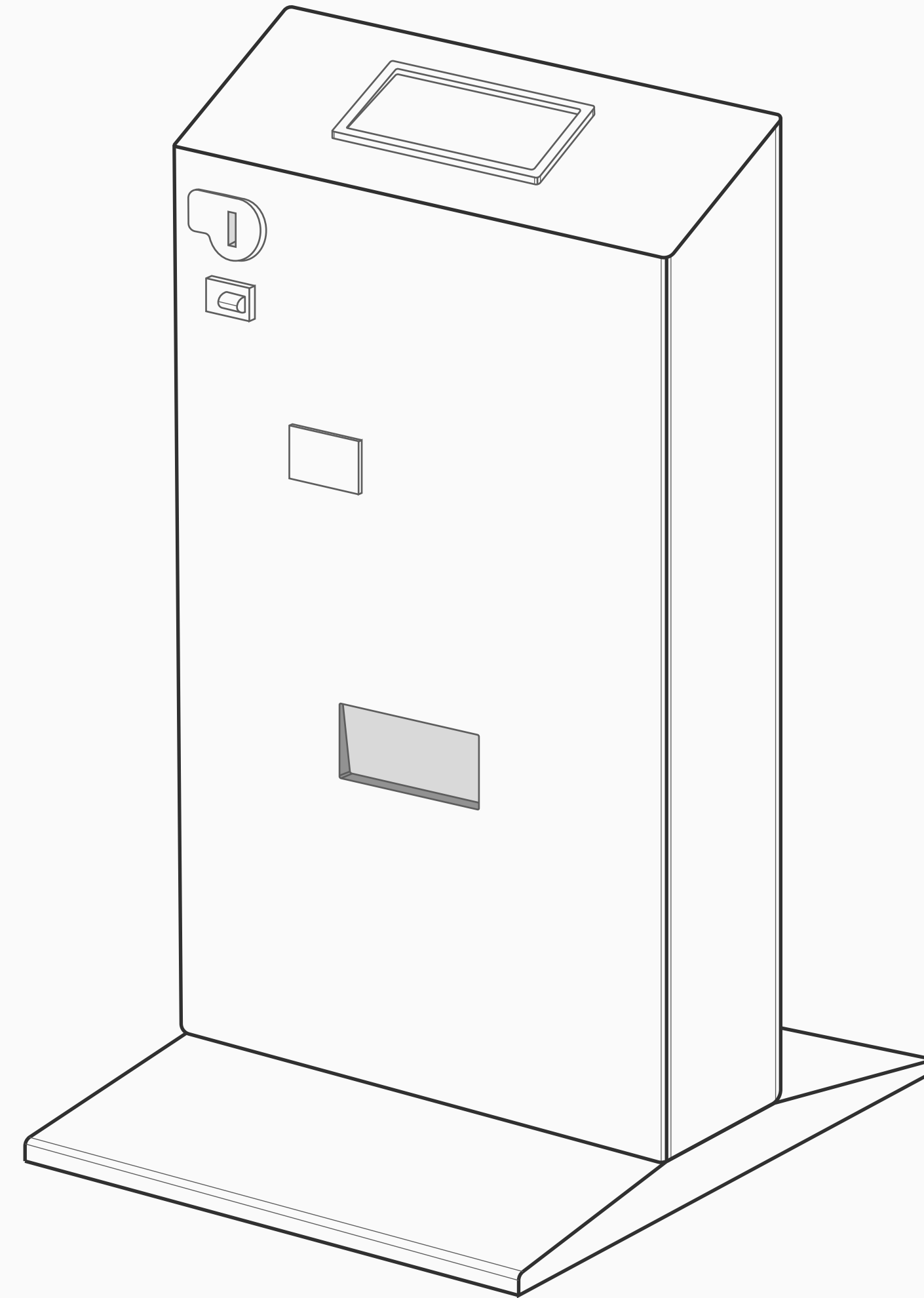

DRC9

Flexibility, simplicity, robustness make it ideal for the sale of self-service photocopying

5600€

- Plată cu fise, bancnote si card
- Distribuitor + reincarcator de carduri
- Copiere/print/scan full

CONTACT

T: (+40) 254 233

M: contact@rdtooffice.ro

W: www.rdtooffice.ro

